

A3

REV	ECN NO	DESCRIPTION	DATE	APPD
X1		INITIAL EDITION	2017.09.25	Andrew

L3200

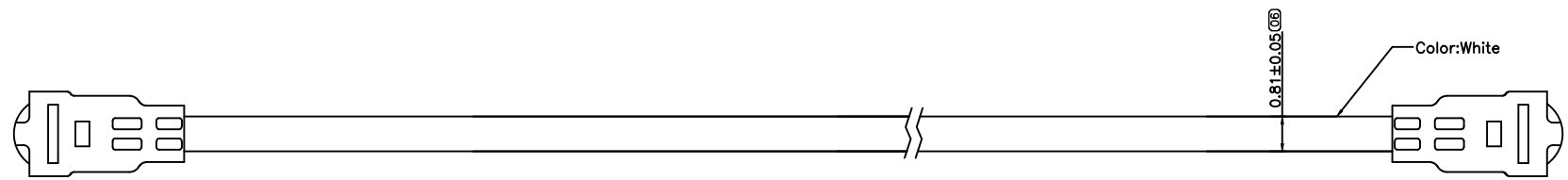
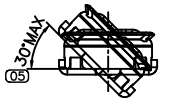
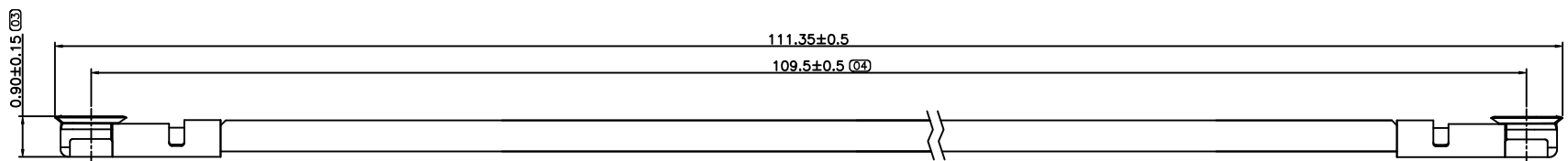
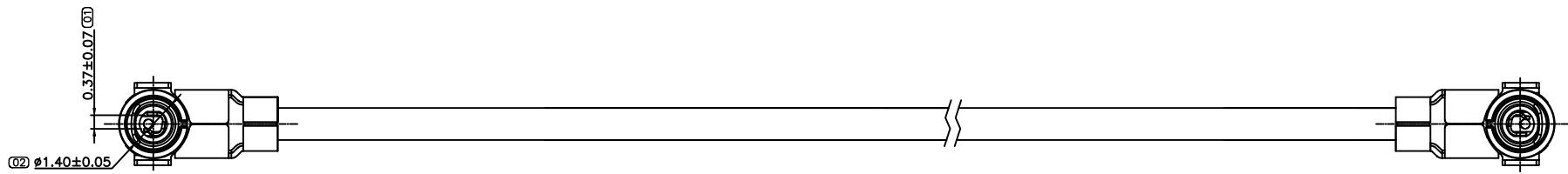

- Note:
- Technology Parameter
 - Voltage Rating: 60VAC(R.M.S)
 - Frequency Rating: 0~6GHz
 - Nominal Characteristic Impedance: 50 ohms
 - Operating Temperature Range: -40°C~+85°C
 - Operating Humidity: 95%R.H.MAX
 - Electric Performance
 - Insulation Resistance: 500M ohms
 - Contact Resistance
 - Inner Contact: 25 mohms Max.
 - Outer Contact: 25 mohms Max.
 - Withstand Voltage: 200V AC 1minute
 - VSWR: 500M~3GHz<1.3
 - Insertion loss:3GHz<0.6dB
 - Mechanism Performance
 - Durability: 30 Cycles
 - The Product is Compliant With FAF Environment Procedure Requirement

EXTEND USE			TITLE	
RF 1.2H CONNECTOR PLUG+CABLE			7.023AJ CONNECTOR CUSTOMER DRAWING	
GENERAL TOLERANCE (D)		UNIT	APPD	DWG NO
DIMENSION		mm	Andrew	C-7.023AJ
ANGLES		MATERIAL	2017.09.25	P/N:
. ±0.30	. ±3°	QTY	CHD	7.023AJ-068-1B0
.0 ±0.25	.0 ±2°	FINISHED	DRN	SHEET
.00 ±0.20	.00 ±1°	BillZheng	2017.09.25	SCALE
.000 ±0.10				1/1
				1:1
				REV
				X1

A3

REV	ECN NO	DESCRIPTION	DATE	APPD
		SEE SHEET 1		

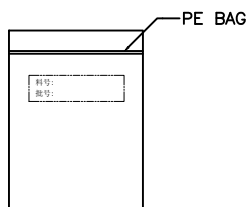

20PCS

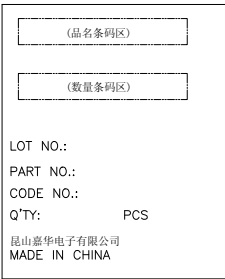

LABLE-INNER BOX

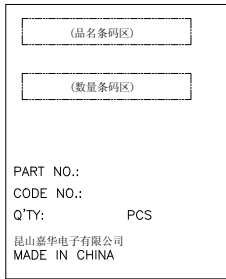

LABLE-CARTON

BOM:

P/N	Q' TY		
	PE BAG	INNER BOX	CARTON
7.023AJ-068-1B0	500PCS	4000PCS	16000PCS

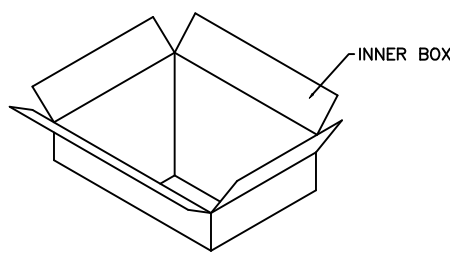

↓

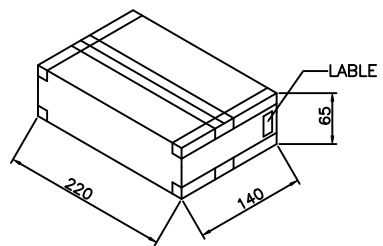

4PCS

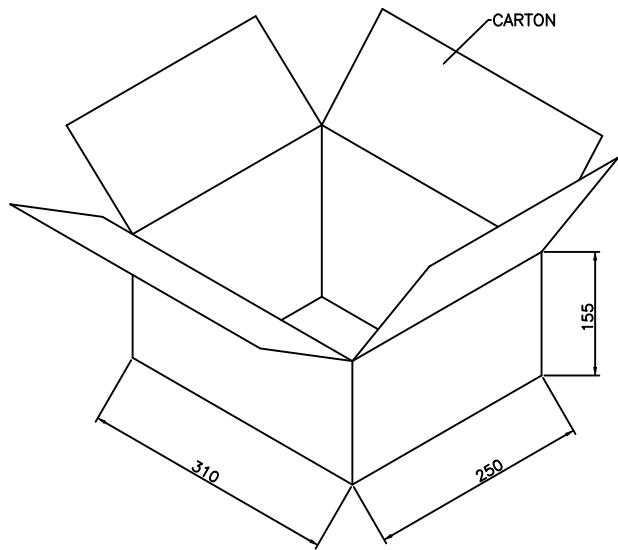

→

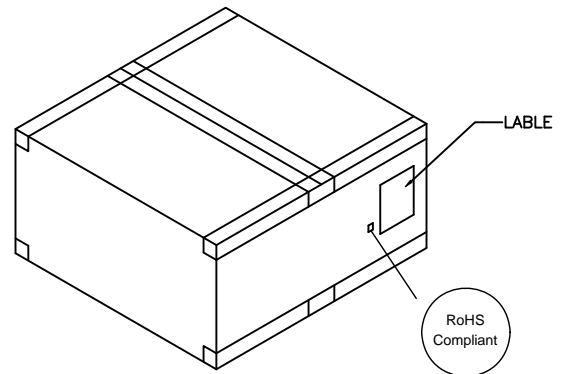

RoHS LABLE

EXTEND USE		TITLE		DWG NO	
RF 1.2H CONNECTOR PLUG+CABLE		7.023AJ CONNECTOR CUSTOMER DRAWING		C-7.023AJ	
GENERAL TOLERANCE		MATERIAL		P/N:	
①		Andrew 2017.09.25		SEE TABLE	
DIMENSION		FINISHED		SHEET	
. ±0.30	ANGLES ±3°	DRN		1/1	
.0 ±0.25	. ±2°	Billzheng 2017.09.25		SCALE	
.00 ±0.20	.00 ±1°			1:1	
.000 ±0.10				REV	
				X1	